



**HVAC** air distribution  
SOLUTIONS

# Shoemaker® Fire-rated dampers

## Now Stocking Fire Dampers

For fire and smoke control in  
commercial and industrial  
HVAC systems



## 2502 Series

### Thin-line Frame 1½ Hour Rated Fire Damper

Code	Description
2502	10" X 10"
2502	14" X 14"
2502	14" X 6"



#### FEATURES

- 2" thin-line roll formed frame
- Building materials rated 2 hours or less
- Interlocking steel roll-formed blades
- Blade lock to secure blades once product is activated
- Damper manufactured from corrosion tested galvanized mild steel (G-90)
- 165° replaceable fusible link

**APPLICATION** • Designed for use in walls, floors and partitions with fire resistance ratings of 1½ hours or less (for ceiling application)

**RECOMMENDED FOR** • Commercial applications

**OPTIONS** • Vertical mount only, maximum one piece size 48" W, 49" H

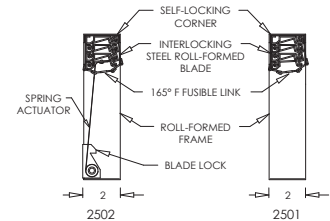
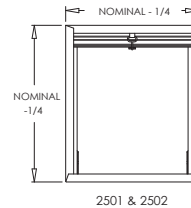
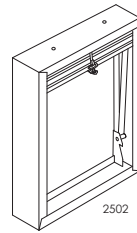
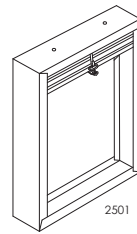

## 2602 Series

### Standard Frame 1½ Hour Rated Fire Damper

Code	Description
2602	6" X 6"
2602	8" X 8"
2602	10" X 10"
2602	10" X 4"
2602	12" X 12"
2602	12" X 4"
2602	12" X 6"
2602	12" X 8"
2602	14" X 10"
2602	14" X 14"
2602	14" X 8"
2602	16" X 16"
2602	18" X 18"
2602	20" X 10"
2602	20" X 12"
2602	24" X 14"
2602	24" X 24"



#### FEATURES

- Building materials rated 2 hours or less
- Interlocking steel roll-formed blades
- Blade lock to secure blades once product is activated
- Corrosion tested galvanized mild steel (G-90)
- 165° replaceable fusible link (#50)

**APPLICATION** • Designed for use in walls, floors and partitions with fire resistance ratings of 2 hours or less (for ceiling application, see 2700 series)

**RECOMMENDED FOR** • Commercial applications

**OPTIONS** • Vertical mount only without spring actuator and blade lock, maximum size single section 60"×60" or multiple sections

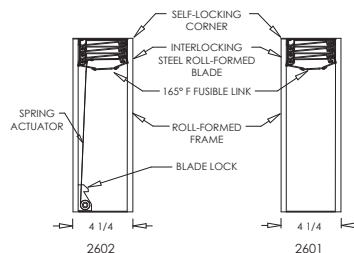
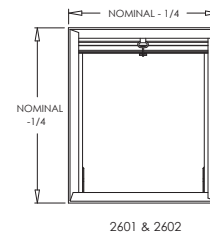
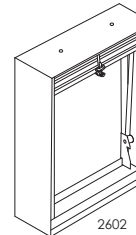
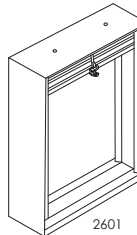

# 2650 Series

## Round Out-of-Airstream 1½ Hour Rated Fire Damper

Code	Description
2650	4" Round
2650	6" Round
2650	8" Round
2650	10" Round
2650	12" Round
2650	14" Round
2650	16" Round



UL 555C



### FEATURES

- 4 1/4" standard roll formed out-of-airstream frame
- 1 1/2 hour fire resistance rating
- Building materials rated 2 hours or less
- Interlocking steel roll-formed blades
- Blade lock to secure blades once product is activated
- Damper manufactured from corrosion-tested galvanized mild steel (G-90)
- 165° replaceable fusible link
- Available in 4" through 52" round

**APPLICATION** • Designed for use in walls, floors and partitions with fire resistance ratings of 2 hours or less

**RECOMMENDED FOR** • Commercial applications

**OPTIONS** • Vertical mount only without spring actuator and blade lock • Available in 4" – 52" round

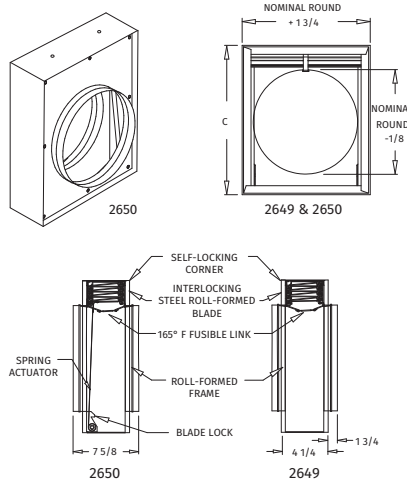
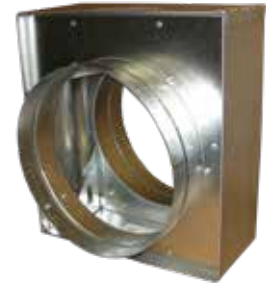

2650 Dimensions	
Duct Size	Height (C)
4" - 7"	+1 3/4"
8" - 16"	+2 3/4"
17" - 26"	+3 3/4"
27" - 35"	+4 3/4"
36" - 44"	+5 3/4"
45" - 52"	+6 3/4"

Example: Height (C) for 20" duct would be 23 3/4"

# 2701 Series

## 3 Hour Rated Ceiling Radiation Butterfly Damper

Code	Description
2701	6" X 6"
2701	8" X 8"
2701	10" X 10"
2701	12" X 12"
2701	14" X 14"
2701	14" X 6"
2701	14" X 8"



UL 555C



### FEATURES

- Building materials rated 3 hours or less
- All steel parts with galvanized finish or zinc coating
- 22 gauge galvanized steel roll formed frame and butterfly blades
- Ceramic fiber blade insulation with fiberglass cover\*
- 165° replaceable fusible link

**APPLICATION** • Designed for protection of ceiling openings in fire rated floor/ceiling assemblies with fire resistance ratings of 3 hours or less

**RECOMMENDED FOR** • Commercial applications

**OPTIONS** • Extended sleeve Model 2702  
• 212° fusible link • Size: minimum 4" X 4", max 24" X 24"

\* Ceramic fiber blade insulation is not required by UL required on dampers with free areas less than 80 sq. inches. Dampers with free areas greater than 80 sq. inches are constructed with ceramic fiber blade insulation.



2701 Extended Sleeve Height	
Duct Size	Height (H)
6" - 10"	8"
12" - 14"	10"
15" - 18"	12"
20" - 22"	14"
24"	15"

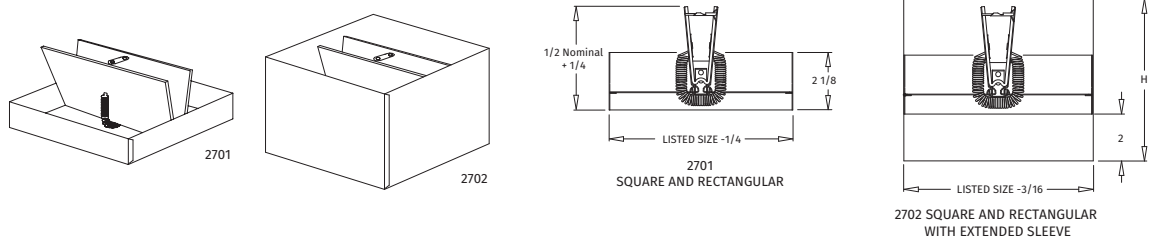

# 2750 Series

## Round 3 Hour Rated Ceiling Radiation Butterfly Damper

Code	Description
2750	4" Round
2750	6" Round
2750	8" Round
2750	10" Round
2750	12" Round
2750	14" Round
2750	16" Round



### FEATURES

- Building materials rated 3 hours or less
- All steel parts with galvanized finish or zinc coating
- 22 gauge galvanized steel roll formed frame and butterfly blades
- Ceramic fiber blade insulation with fiberglass cover\*
- 165° replaceable fusible link

**APPLICATION** • Designed for protection of ceiling openings in fire rated floor/ceiling assemblies with fire resistance ratings of 3 hours or less

**RECOMMENDED FOR** • Commercial applications

**OPTIONS** • Extended sleeve Model 2751

- 212° fusible link • Available in 4" - 24" round

\* Ceramic fiber blade insulation is not required by UL required on dampers with free areas less than 80 sq. inches. Dampers with free areas greater than 80 sq. inches are constructed with ceramic fiber blade insulation.

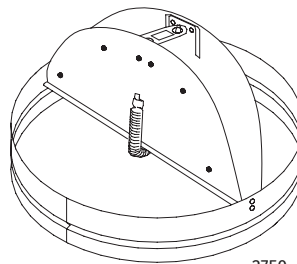

2750  
ROUND

2750 Extended Sleeve Height	
Duct Size	Height (H)
4" - 10"	8"
12" - 14"	10"
15" - 18"	12"
20" - 22"	14"
24"	15"

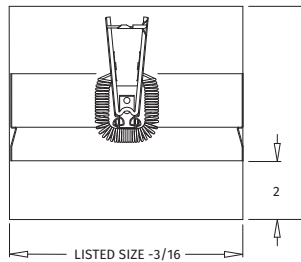

2751  
ROUND WITH EXTENDED SLEEVE

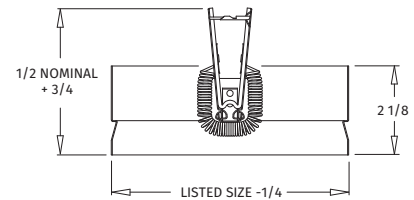

2750  
ROUND

RectorSeal, LLC 2601 Spenwick Drive, Houston, TX 77055, USA • 866-940-0696 • [rs.today/shoemaker](http://rs.today/shoemaker)

A CSW Industrials Company. RectorSeal, the logos and other trademarks are property of RectorSeal, LLC, its affiliates or its licensor's and are protected by copyright, trademark and other intellectual property laws, and may not be used without permission. RectorSeal reserves the right to change specifications without prior notice.

©2024 RectorSeal. All rights reserved. R51109-0124